

## BELLA SUSPENSION

### D81667-MBR

PROJECT \_\_\_\_\_

TYPE \_\_\_\_\_

NOTES \_\_\_\_\_

QUANTITY \_\_\_\_\_

DATE \_\_\_\_\_

#### GENERAL

Series: Bella

Brand: Panzeri

Division: Design

Mounting Type: Suspension

Mounting Location: Ceiling

Subcategory: Pendant

#### PHYSICAL

Shape: Disc

Diameter (mm): 101

Diameter (in): 4

Height (mm): 13

Height (in): 1/2

Max. Overall Height (mm): 3013

Max. Overall Height (in): 118 <sup>5</sup>/<sub>8</sub>

Light Distribution: Direct

Weight (kg): 0.54501

Weight (lbs): 1.2

Diffuser: Opal - Acrylic

Fixture Material: Metal

#### ELECTRICAL

Lamp Type: LED

Input Wattage (W): 6.5

Total Output Wattage (W): 6.5

Dimming: Non-Dimmable

Driver Location: Integrated

Input Voltage (V): 120

#### LED

Delivered Lumen Range: 100 - 499 lm

Number of LEDs: 1

Color Temperature (°K): 2700

Max. Delivered Lumen (lm): 388

Nominal Lumen (lm): 460

CRI: >80 CRI

#### OPTICAL

#### RATINGS AND CERTIFICATIONS

Certified By: CSA Certified to UL and CSA Standards

IP rating: IP40

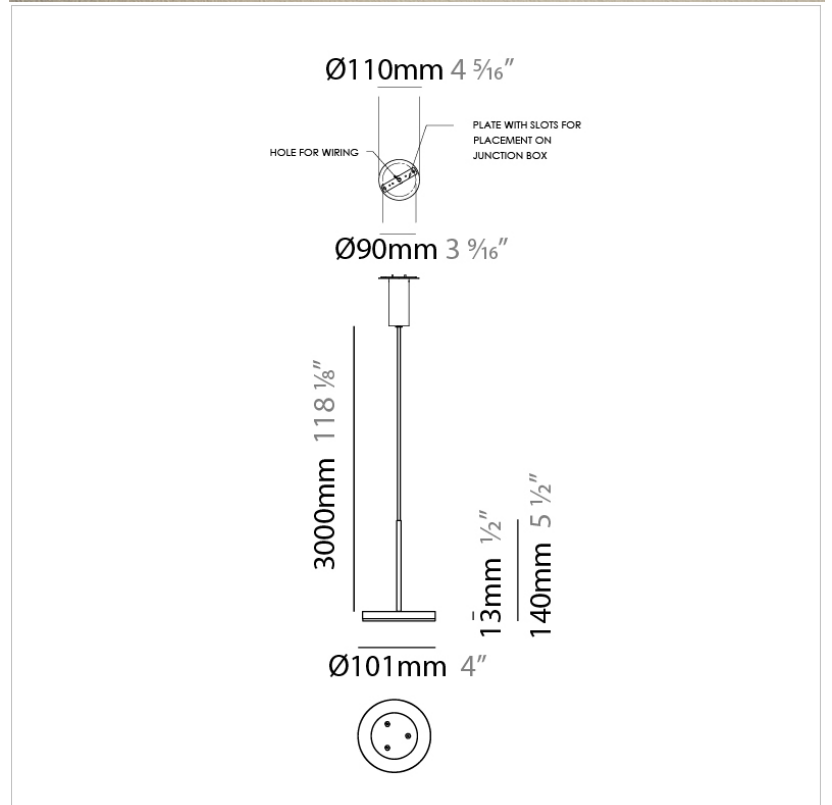

D

## BELLA SUSPENSION

### D81667-TIM

PROJECT	
TYPE	
NOTES	
QUANTITY	
DATE	

#### GENERAL

Series: Bella  
 Brand: Panzeri  
 Division: Design  
 Mounting Type: Suspension  
 Mounting Location: Ceiling  
 Subcategory: Pendant

#### PHYSICAL

Shape: Disc  
 Diameter (mm): 101  
 Diameter (in): 4  
 Height (mm): 13  
 Height (in): 1/2  
 Max. Overall Height (mm): 3013  
 Max. Overall Height (in): 118 <sup>5</sup>/<sub>8</sub>  
 Light Distribution: Direct  
 Weight (kg): 0.54501  
 Weight (lbs): 1.2  
 Diffuser: Opal - Acrylic  
 Fixture Material: Metal

#### ELECTRICAL

Lamp Type: LED  
 Input Wattage (W): 6.5  
 Dimming: Non-Dimmable  
 Driver Location: Integrated  
 Input Voltage (V): 120

#### LED

Number of LEDs: 1  
 Color Temperature (°K): 2700  
 Max. Delivered Lumen (lm): 388  
 Nominal Lumen (lm): 460  
 CRI: >80 CRI

#### OPTICAL

#### RATINGS AND CERTIFICATIONS

Certified By: CSA Certified to UL and CSA Standards  
 IP rating: IP40

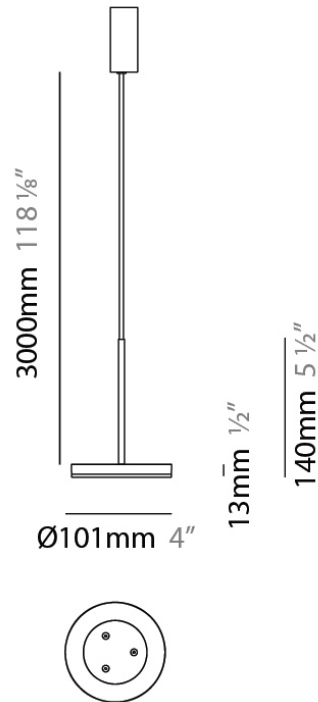

## BELLA SUSPENSION

### D81667R9-BRZ

PROJECT \_\_\_\_\_

TYPE \_\_\_\_\_

NOTES \_\_\_\_\_

QUANTITY \_\_\_\_\_

DATE \_\_\_\_\_

#### GENERAL

Series: Bella  
 Brand: Panzeri  
 Division: Design  
 Mounting Type: Suspension  
 Mounting Location: Ceiling  
 Subcategory: Pendant

#### PHYSICAL

Shape: Round  
 Diameter (mm): 101  
 Diameter (in): 4  
 Height (mm): 13  
 Height (in): 1/2  
 Max. Overall Height (mm): 3013  
 Max. Overall Height (in): 118 <sup>5</sup>/<sub>8</sub>  
 Light Distribution: Direct  
 Weight (kg): 0.54501  
 Weight (lbs): 1.2  
 Diffuser: Opal - Acrylic  
 Fixture Material: Aluminum Die Cast  
 Cable Details: 3000mm / 118 1/8" Cable

#### ELECTRICAL

Lamp Type: LED  
 Input Wattage (W): 6.5  
 Total Output Wattage (W): 4.5  
 Dimming: Non-Dimmable  
 Driver Included: Yes  
 Driver Location: Integrated  
 Driver Type: Constant Voltage - Universal  
 Driver Class: Class 2  
 Input Voltage (V): 120 - 277

#### LED

Color Temperature (°K): 2700  
 Max. Delivered Lumen (lm): 388  
 Nominal Lumen (lm): 460  
 CRI: >90 CRI  
 Lamp Life (hrs): 50000

#### OPTICAL

#### RATINGS AND CERTIFICATIONS

Certified By: CSA Certified to UL and CSA Standards  
 IP rating: IP40

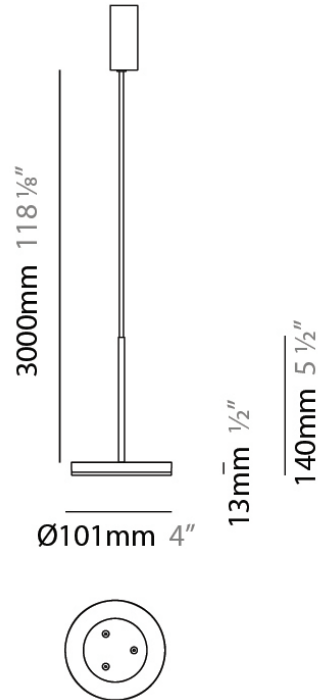

## BELLA SUSPENSION

### D81667R9-TIM

PROJECT \_\_\_\_\_

TYPE \_\_\_\_\_

NOTES \_\_\_\_\_

QUANTITY \_\_\_\_\_

DATE \_\_\_\_\_

#### GENERAL

Series: Bella

Brand: Panzeri

Division: Design

Mounting Type: Suspension

Mounting Location: Ceiling

Subcategory: Pendant

#### PHYSICAL

Shape: Round

Diameter (mm): 101

Diameter (in): 4

Height (mm): 13

Height (in): 1/2

Max. Overall Height (mm): 3013

Max. Overall Height (in): 118 5/8

Light Distribution: Direct

Weight (kg): 0.54501

Weight (lbs): 1.2

Diffuser: Acrylic Diffuser With Matt Finish

Fixture Material: Aluminum Die Cast

Cable Details: 3000mm / 118 1/8" Cable

#### ELECTRICAL

Lamp Type: LED

Input Wattage (W): 6.5

Total Output Wattage (W): 4.5

Dimming: Non-Dimmable

Driver Included: Yes

Driver Location: Integrated

Driver Type: Constant Voltage - Universal

Driver Class: Class 2

Input Voltage (V): 120 - 277

#### LED

Color Temperature (°K): 2700

Max. Delivered Lumen (lm): 388

CRI: >90 CRI

Lamp Life (hrs): 50000

#### OPTICAL

#### RATINGS AND CERTIFICATIONS

Certified By: CSA Certified to UL and CSA Standards

IP rating: IP40

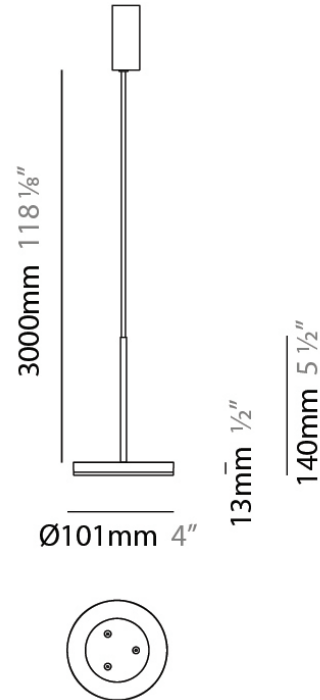

## BELLA SUSPENSION

### D81668-BRZ

PROJECT \_\_\_\_\_

TYPE \_\_\_\_\_

NOTES \_\_\_\_\_

QUANTITY \_\_\_\_\_

DATE \_\_\_\_\_

#### GENERAL

Series: Bella  
 Brand: Panzeri  
 Division: Design  
 Mounting Type: Suspension  
 Mounting Location: Ceiling  
 Subcategory: Pendant

#### PHYSICAL

Diameter (mm): 101  
 Diameter (in): 4  
 Height (mm): 13  
 Height (in): 1/2  
 Max. Overall Height (mm): 3013  
 Max. Overall Height (in): 118 7/8  
 Light Distribution: Indirect  
 Weight (kg): 0.54501  
 Weight (lbs): 1.2  
 Diffuser: Opal - Acrylic  
 Fixture Material: Aluminum Die Cast

#### ELECTRICAL

Lamp Type: LED  
 Input Wattage (W): 6.5  
 Dimming: Non-Dimmable  
 Driver Included: Yes  
 Driver Location: Integrated  
 Driver Type: Constant Voltage - Universal  
 Driver Class: Class 2  
 Input Voltage (V): 120

#### LED

Color Temperature (°K): 2700  
 Max. Delivered Lumen (lm): 467  
 CRI: >80 CRI

#### OPTICAL

#### RATINGS AND CERTIFICATIONS

Certified By: CSA Certified to UL and CSA Standards  
 IP rating: IP40

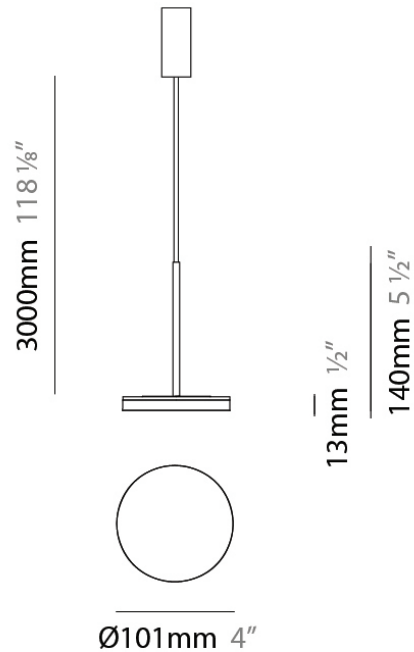

## BELLA SUSPENSION

### D81668-TIM

PROJECT \_\_\_\_\_

TYPE \_\_\_\_\_

NOTES \_\_\_\_\_

QUANTITY \_\_\_\_\_

DATE \_\_\_\_\_

#### GENERAL

Series: Bella

Brand: Panzeri

Division: Design

Mounting Type: Suspension

Mounting Location: Ceiling

Subcategory: Pendant

#### PHYSICAL

Diameter (mm): 101

Diameter (in): 4

Height (mm): 13

Height (in): 1/2

Max. Overall Height (mm): 3013

Max. Overall Height (in): 118 7/8

Light Distribution: Indirect

Weight (kg): 0.54501

Weight (lbs): 1.2

Diffuser: Opal - Acrylic

Fixture Material: Aluminum Die Cast

Cable Details: 3000mm / 118 1/8" Cable

#### ELECTRICAL

Lamp Type: LED

Input Wattage (W): 6.5

Driver Location: Integrated

Input Voltage (V): 120

#### LED

Number of LEDs: 1

Color Temperature (°K): 2700

Max. Delivered Lumen (lm): 388

Nominal Lumen (lm): 460

CRI: >80 CRI

#### OPTICAL

#### RATINGS AND CERTIFICATIONS

Certified By: CSA Certified to UL and CSA Standards

IP rating: IP40

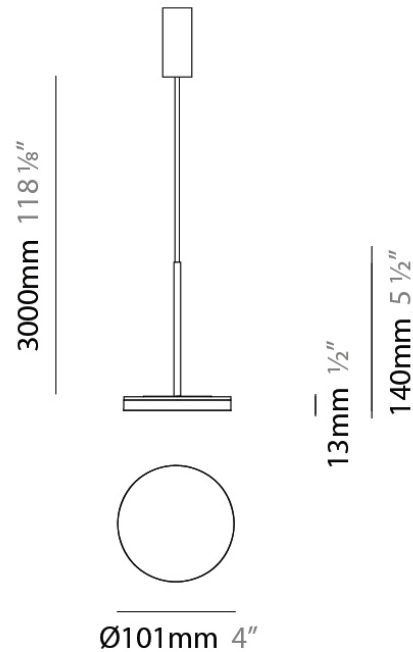

## BELLA SUSPENSION

### D81668-WHI

PROJECT \_\_\_\_\_

TYPE \_\_\_\_\_

NOTES \_\_\_\_\_

QUANTITY \_\_\_\_\_

DATE \_\_\_\_\_

#### GENERAL

Series: Bella  
 Brand: Panzeri  
 Division: Design  
 Mounting Type: Suspension  
 Mounting Location: Ceiling  
 Subcategory: Pendant

#### PHYSICAL

Diameter (mm): 101  
 Diameter (in): 4  
 Height (mm): 13  
 Height (in): 1/2  
 Max. Overall Height (mm): 3013  
 Max. Overall Height (in): 118 7/8  
 Light Distribution: Indirect  
 Weight (kg): 0.54501  
 Weight (lbs): 1.2  
 Diffuser: Opal - Acrylic  
 Fixture Material: Aluminum Die Cast

#### ELECTRICAL

Lamp Type: LED  
 Input Wattage (W): 6.5  
 Dimming: Non-Dimmable  
 Driver Included: Yes  
 Driver Location: Integrated  
 Driver Type: Constant Voltage - Universal  
 Driver Class: Class 2  
 Input Voltage (V): 120

#### LED

Color Temperature (°K): 2700  
 Max. Delivered Lumen (lm): 467  
 CRI: >80 CRI

#### OPTICAL

#### RATINGS AND CERTIFICATIONS

Certified By: CSA Certified to UL and CSA Standards  
 IP rating: IP40

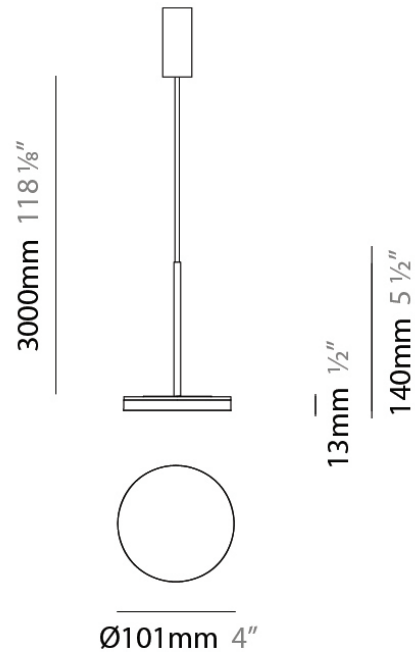

## BELLA SUSPENSION

### D81668R9-BLK

PROJECT	
TYPE	
NOTES	
QUANTITY	
DATE	

#### GENERAL

Series: Bella  
 Brand: Panzeri  
 Division: Design  
 Mounting Type: Suspension  
 Mounting Location: Ceiling  
 Subcategory: Pendant

#### PHYSICAL

Diameter (mm): 101  
 Diameter (in): 4  
 Height (mm): 13  
 Height (in): 1/2  
 Max. Overall Height (mm): 3013  
 Max. Overall Height (in): 118 7/8  
 Light Distribution: Indirect  
 Weight (kg): 0.54501  
 Weight (lbs): 1.2  
 Diffuser: Opal - Acrylic  
 Fixture Material: Aluminum Die Cast

#### ELECTRICAL

Lamp Type: LED  
 Input Wattage (W): 6.5  
 Dimming: Non-Dimmable  
 Driver Included: Yes  
 Driver Location: Integrated  
 Driver Type: Constant Voltage - Universal  
 Driver Class: Class 2  
 Input Voltage (V): 120

#### LED

Color Temperature (°K): 2700  
 Max. Delivered Lumen (lm): 388  
 CRI: >90 CRI

#### OPTICAL

#### RATINGS AND CERTIFICATIONS

Certified By: CSA Certified to UL and CSA Standards  
 IP rating: IP40

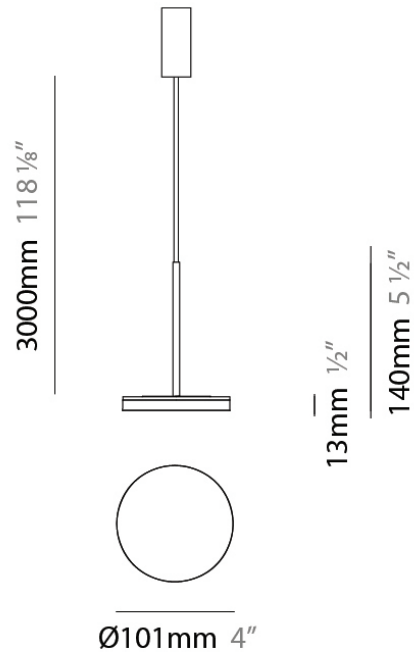



## BELLA SUSPENSION

### D81668R9-WHI

PROJECT \_\_\_\_\_

TYPE \_\_\_\_\_

NOTES \_\_\_\_\_

QUANTITY \_\_\_\_\_

DATE \_\_\_\_\_

#### GENERAL

Series: Bella  
 Brand: Panzeri  
 Division: Design  
 Mounting Type: Suspension  
 Mounting Location: Ceiling  
 Subcategory: Pendant

#### PHYSICAL

Diameter (mm): 101  
 Diameter (in): 4  
 Height (mm): 13  
 Height (in): 1/2  
 Max. Overall Height (mm): 3013  
 Max. Overall Height (in): 118 7/8  
 Light Distribution: Indirect  
 Weight (kg): 0.54501  
 Weight (lbs): 1.2  
 Diffuser: Opal - Acrylic  
 Fixture Material: Aluminum Die Cast

#### ELECTRICAL

Lamp Type: LED  
 Input Wattage (W): 6.5  
 Dimming: Non-Dimmable  
 Driver Included: Yes  
 Driver Location: Integrated  
 Driver Type: Constant Voltage - Universal  
 Driver Class: Class 2  
 Input Voltage (V): 120

#### LED

Color Temperature (°K): 2700  
 Max. Delivered Lumen (lm): 388  
 CRI: >90 CRI







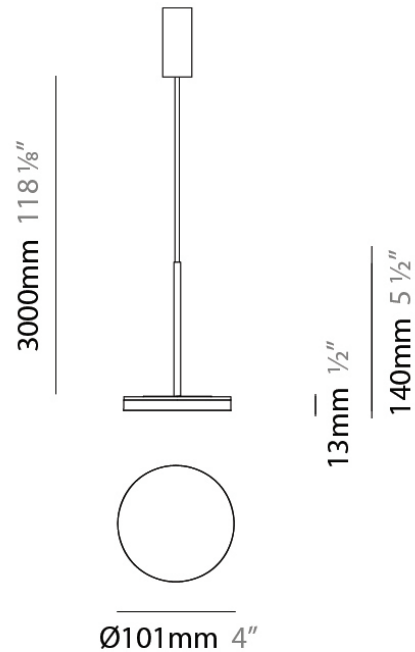





























































#### OPTICAL

#### RATINGS AND CERTIFICATIONS











Certified By: CSA Certified to UL and CSA Standards  
 IP rating: IP40













## LEGEND

	floor-mounted		pivotal		special LED (upon request) RGB, RGBW, tunable, gold+, meat+, art+, fashion+
	wall and ceiling: recessed and surface mounted		rotating		warm dim / natural dimming LED
	ceiling-mounted and wall-mounted		illuminate tilted		rechargeable battery powered
	wall-mounted		color of suspension cable		fixture with natural vivid LED (upon request)
	omni-directional light distribution		length of suspension cable		color rendering index
	direct light distribution		reflector degree selection		color temperature
	direct/indirect light distribution		super spot		lumen (luminous flux)
	indirect light distribution		lens		efficacy (lumens per watt)
	asymmetric light distribution		lens pack		Unified Glare Rating (UGR) range from 5-40
	aura light distribution		shine ring		marine grade (AISI 316 stainless steel)
	round wall or ceiling cut-out		integrated shine ring with diffuser		walk on
	square wall or ceiling cut-out		free individual colors 01-29		drive on
	the supplied jig specifies the cutout dimensions		individual colors: 00 (free of charge), 01-25 (extra charge)		Dark Sky Compliance
	minimum distance (meters) lamp - object		luminaire part to be colored (F1)		Americans with Disabilities Act (less than 4" off the wall located between 27"-84" from floor)
	recessed depth		luminaire part to be colored (F2)		lamp protected against explosion
	ceiling thickness in mm		luminaire part to be colored (F3)		blown glass using traditional methods by master glass blower
	ceiling thickness selection		luminaire part to be colored (F4)		acoustic material
	dimmable DP (phase), DV (0-10V), DD (dali), DS (step-dim)		luminaire part to be colored (F5)		protection class I, protection insulation
	included or excluded LED driver/transformer/control gear		color of 3-circuit adaptor		protection class II, protection insulation
	separately switchable		indirect diffuser		ETL Certified to UL and CSA Standards
	sensor		direct diffuser		UL Certified to UL and CSA Standards
	remote control		ball-proof (upon request)		CSA Certified to UL and CSA Standards
	available upon request		accessory		Certified for North American Standards

## IP RATING

	protected against ingress of solid bodies greater than 12.5mm (finger)
	protected against ingress of solid bodies greater than 2.5mm protected against sprays of water up to 60 degrees from the vertical (rain)
	protected against ingress of solid bodies greater than 1mm (wire) no protection against the ingress of moisture
	protected against ingress of solid bodies greater than 1mm (wire) protected against sprays of water up to 60 degrees from the vertical (rain)
	protected against ingress of solid bodies greater than 1mm (wire) protected against water splashed from all directions
	protected against limited ingress of dust (wet rooms/covered outdoor areas) protected against water splashed from all directions
	protected against ingress of dust protected against jets of water
	protected against ingress of dust protected against powerful jets of water or heavy seas
	protected against ingress of dust protected against immersion of water between 15cm - 1m for 30 minutes
	protected against ingress of dust protected against immersion of water under pressure for long periods

## IK RATING

	protected against 0.14 joules impact (equivalent to 0.25kg mass dropped from 56mm above the surface)
	protected against 0.2 joules impact (equivalent to 0.25kg mass dropped from 80mm above the surface)
	protected against 0.35 joules impact (equivalent to 0.25kg mass dropped from 140mm above the surface)
	protected against 0.5 joules impact (equivalent to 0.25kg mass dropped from 200mm above the surface)
	protected against 0.7 joules impact (equivalent to 0.25kg mass dropped from 280mm above the surface)
	protected against 1 joules impact (equivalent to 0.25kg mass dropped from 400mm above the surface)
	protected against 2 joules impact (equivalent to 0.5kg mass dropped from 400mm above the surface)
	protected against 5 joules impact (equivalent to 1.7kg mass dropped from 300mm above the surface)
	protected against 10 joules impact (equivalent to 5.0kg mass dropped from 200mm above the surface)
	protected against 20 joules impact (equivalent to 5.0kg mass dropped from 400mm above the surface)